



FRT

RETURN FILTER FOR FLANGE MOUNTING ON THE TANK

SERIES 10

p max 3 bar
Q max (see performance table)

OPERATING PRINCIPLE

- FRT filters are designed to be flange-mounted on the tank cover; the BSP threaded port for the input connection is positioned on the filter head and is therefore very accessible.
- The inspection cover fixed with three or four screws allows easy maintenance; the filter element is supplied with a screw, which makes its removal together with the container easier. In this way, by replacing the filter element, it is possible to clean the contamination present in the bowl of the filter.
- The filter element is made of high efficiency filtering materials and is able to hold high quantities of contamination material. It is available with three different filtration degrees:
 - F10 = 10 µm absolute ($\beta_{10} > 100$) - ISO 4406:1999 class 18/16/13
 - F25 = 25 µm absolute ($\beta_{25} > 100$) - ISO 4406:1999 class 19/17/14
 - P10 = 10 µm nominal ($\beta_{10} > 2$) - ISO 4406:1999 class 21/19/16
- FRT filters are always supplied with a by-pass valve.
- All the FRT filters are designed to incorporate an electric or visual clogging indicator, to be ordered separately (see par. 5).

PERFORMANCES

Filter code	BSP port dimensions	Mass [kg]	Rated flow (indicative) [l/min]		
			F10	F25	P10
FRT-TB012	1/2"	0,45	18	25	30
FRT-TB034	3/4"	0,95	50	70	85
FRT-TB100	1"	1,1	65	110	130
FRT-TB114	1 ¼"	2,1	150	190	210
FRT-TB112	1 ½"	3,1	160	250	290
FRT-TB200	2"	4,1	280	400	430

Maximum pressure	bar	3
Collapsing differential pressure of the filter element	bar	3
Differential pressure for the opening of the by-pass valve ($\pm 10\%$)	bar	1,7
Ambient temperature range	°C	-25 / +50
Fluid temperature range	°C	-25 / +110
Fluid viscosity range	cSt	10 ÷ 400

NOTE: the flow rates stated in the table correspond to a 0.5 bar pressure drop measured with mineral oil of viscosity 36 cSt at 50°C. As for a different viscosity range, see **NOTE 2** - par. 2.2.

HYDRAULIC SYMBOL

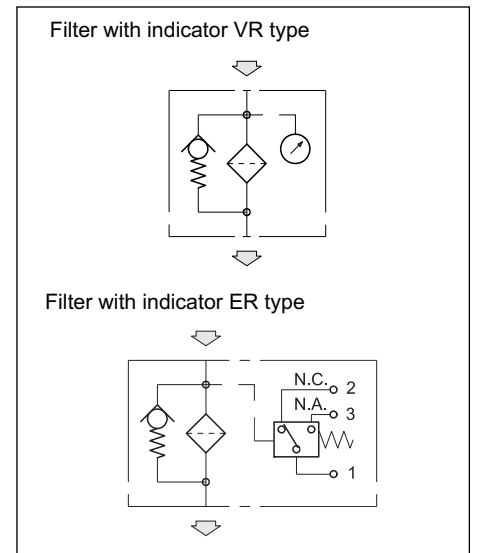



FRT

SERIES 10

1 - IDENTIFICATION CODE

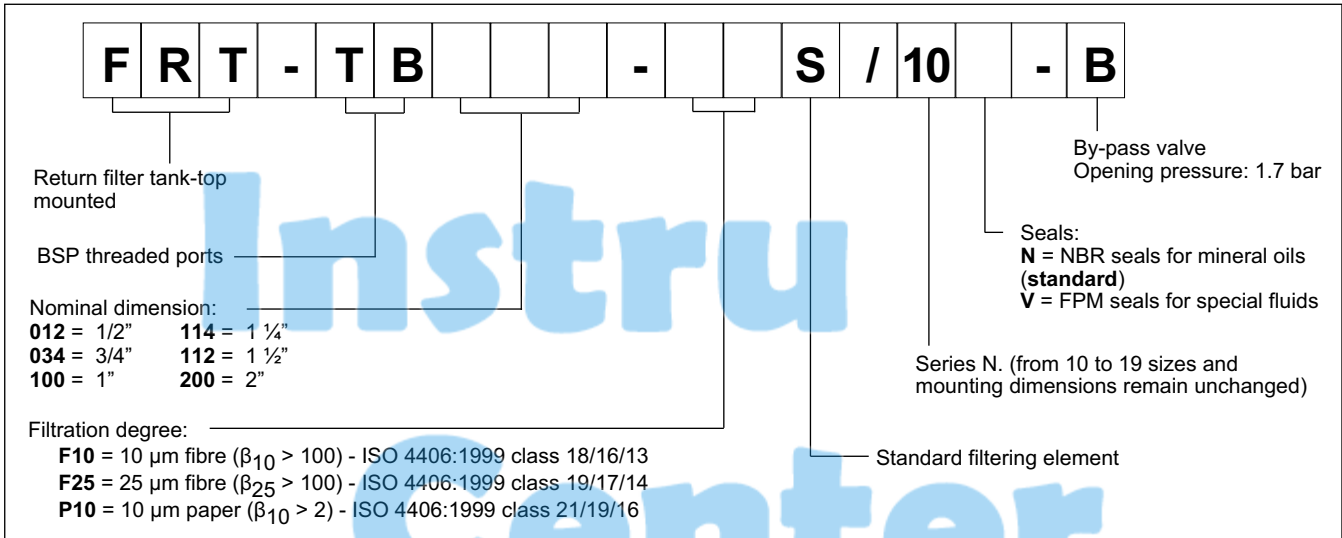

2 - CHARACTERISTIC CURVES (values measured with viscosity of 36 cSt at 50°C)

2.1 - Pressure drops through the filter body

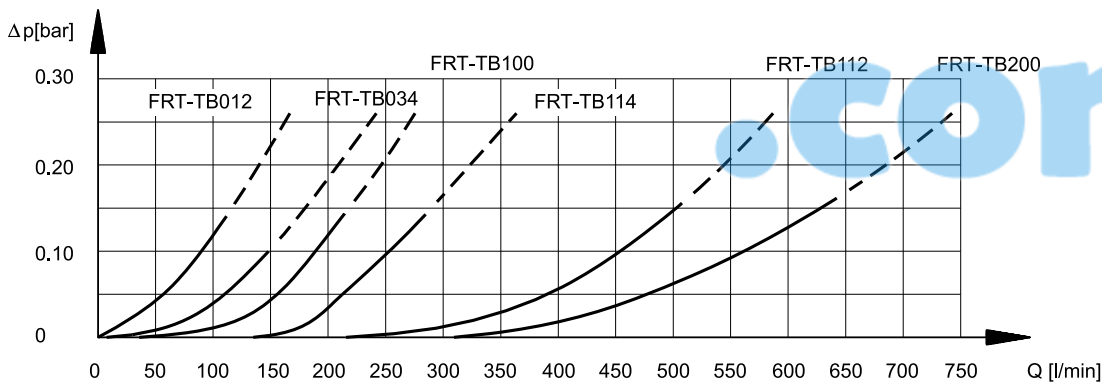

2.2 - Pressure drops through the FRTE filtering element

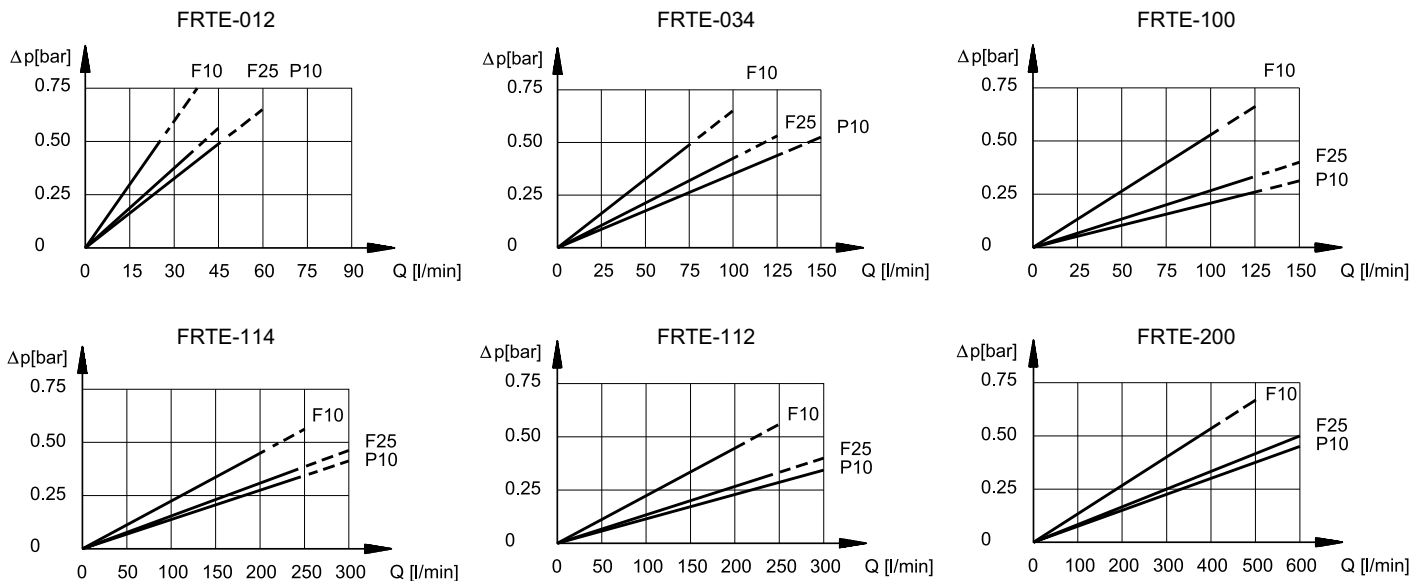



FRT SERIES 10

NOTE 2: the filter size has to be calculated so that with the nominal flow rate the pressure drop is lower than 0.5 bar.

The total pressure drop through the filter is given by adding the body pressure drop values to those of the filter element. As for fluids whose viscosity degree at a specific operating pressure is different from 36 cSt, the filter total pressure drop has to be changed according to the following ratio:

$$\text{total } \Delta p \text{ value} = \text{body } \Delta p \text{ value} + (\text{real } \Delta p \text{ value of the filter element} \times \text{real viscosity value (cSt)} / 36)$$

$$\text{real } \Delta p \text{ value of the filter element} = \text{value obtainable through the diagrams in par. 2.2}$$

Such ratio is valid for a viscosity value up to 200 cSt. For a higher viscosity please consult our technical department.

2.3 - Pressure drops through the by-pass valve

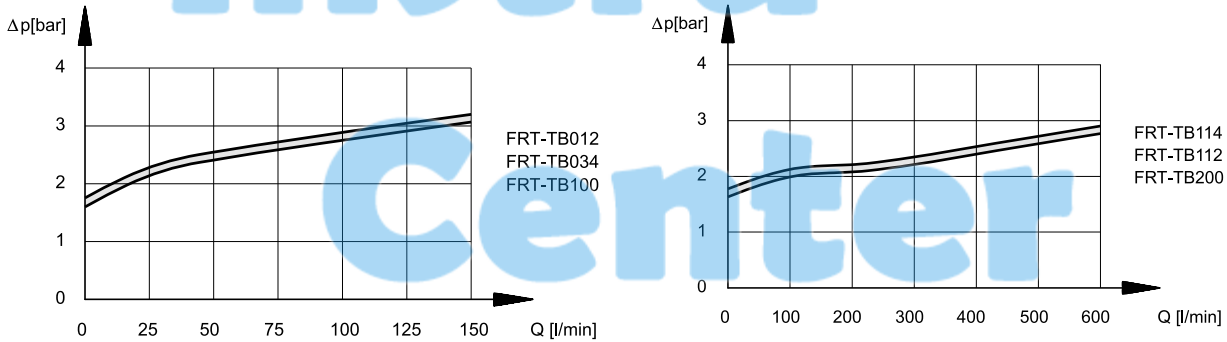

3 - HYDRAULIC FLUIDS

Use mineral oil-based hydraulic fluids HL or HM type, according to ISO 6743-4. For these fluids, use NBR seals (code N). For fluids HFDR type (phosphate esters) use FPM seals (code V). For the use of other kinds of fluid such as HFA, HFB, HFC, please consult our technical department. Using fluids at temperatures higher than 80 °C causes a faster degradation of the fluid and of the seals characteristics.

The fluid must be preserved in its physical and chemical characteristics.

4 - OVERALL AND MOUNTING DIMENSIONS

dimensions in mm

1 Clogging indicator port:
1/8" BSP usually plugged

filter	D1	D2	D3	D4	D5	E	H1	H2	H3	H4	H6	R*
FRT - TB012	1/2"	67	24	90	6.5	50	80	20	22	33	9	120
FRT - TB034	3/4"	89	28	115	9	67	150	25	28	47	10	190
FRT - TB100	1"	89	40	115	9	67	234	30	28	47	10	270
FRT - TB114	1 1/4"	126	40	175	10.5	95	248	50	35	56	13	289
FRT - TB112	1 1/2"	174	20	220	10.5	115	178	50	55	69	13	250
FRT - TB200	2"	174	63.5	220	10.5	115	285	50	55	69	13	355

R * = Filter element removal space starting from the tank surface



FRT

SERIES 10

5 - CLOGGING INDICATORS

The filters are designed to incorporate clogging indicators, which have to be ordered separately.

5.1 - Visual indicator for return filters

Identification code: VR/10

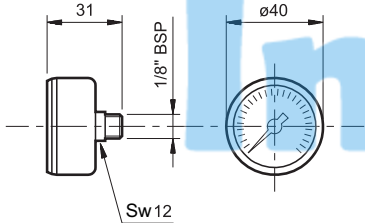

This indicator is a pressure gauge sensitive to the filter input pressure.

The indicator is supplied with a 0 ÷ 6 bar graduated scale and with a two-colour reading scale, which

informs you about the clogging condition of the filter element:

GREEN: efficient filter element (0 ÷ 1.7 bar)

RED: the filter element has to be replaced (> 1.7 bar)

5.2 - Electric indicator for return filters

Identification code: ER/11

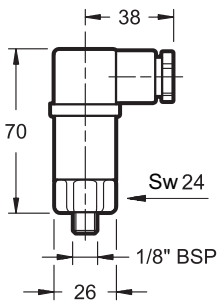

This indicator is a pressure switch sensitive to the filter input pressure, which switches an electrical contact when the filter element has reached the clogging limit.

The contact can be wired in an open or closed condition (see the hydraulic symbol).

TECHNICAL SPECIFICATIONS

Operating pressure	bar	1,5
AC power supply		
Max. operating voltage	VAC	250 50/60 Hz
Max. load on the contacts (inductive or resistive) with V at 125 VAC	A	3
with V at 250 VAC		0,5
DC power supply		
Max. operating voltage	VDC	30
Max. load on the contacts resistive	A	3
inductive		1
Electric connector	DIN 43650	
Class of protection according to CEI EN 60529 (atmospheric agents)	IP65	
Atex classification	3 GD EEx e T6	

6 - FILTER ELEMENTS

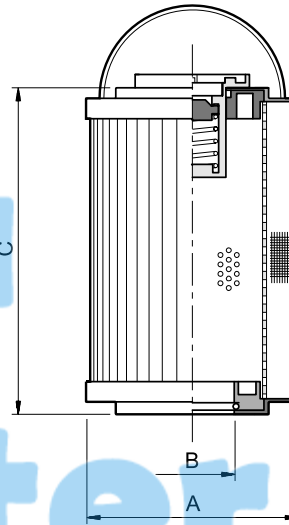

Filter element code	ØA	ØB	C	Average filtering surface [cm²]	
				P10	F12/F25
FRTE - 012	52	24	70	310	380
FRTE - 034	70	28	130	1000	1600
FRTE - 100	70	40	210	1660	2670
FRTE - 114	99	40	211	3800	4280
FRTE - 112	130	51	140	4140	4360
FRTE - 200	130	63	251	7930	8350

FILTER ELEMENT IDENTIFICATION CODE



Filter element for a FRT filter

Nominal dimension
012 = 1/2" **114** = 1 1/4"
034 = 3/4" **112** = 1 1/2"
100 = 1" **200** = 2"

Filtration degree: **F10** = fibre 10 µm
F25 = fibre 25 µm
P10 = paper 10 µm

Standard filter element

Series N. (from 10 to 19 sizes and mounting dimensions are unchanged)

N = NBR seals for mineral oils (**standard**)
V = FPM seals for special fluids (upon request)



DIPLOMATIC OLEODINAMICA S.p.A.
 20015 PARABIAGO (MI) • Via M. Re Depaolini 24
 Tel. +39 0331.895.111
 Fax +39 0331.895.339
 www.diplomatic.com • e-mail: sales.exp@diplomatic.com