

Features:

- Direct solenoid operated directional spool valve as standard version
- Wet pin DC or AC solenoids with removable coils
- perfect outline
- Coils may be replaced without opening the pressure-tight chamber
- Choice of either central or individual electrical connections
- Optional hand over-ride
- long life
- Porting pattern to Din 24 340 form A, ISO 4401 and CETOP-RP 121H



Functional, section

Directional valves basically comprise the housing (1), one or two solenoids (2), control spool (3), and one or two return springs (4). At rest, control spool (3) is held in its central or initial position by means of return springs (4) (except in the case of impulse spools). Control spool (3) is operated by wet pin solenoids (2). The force of solenoid (2) acts on control spool (3) and moves it from its rest position to the desired end position. This permits free flow from P to A and B to T or P to B and A to T.

On de-energizing solenoid (2) control spool (3) is returned to its initial position by return spring (4).

Optional hand over-ride (5) permits control spool (3) to be moved without the solenoids being energized.

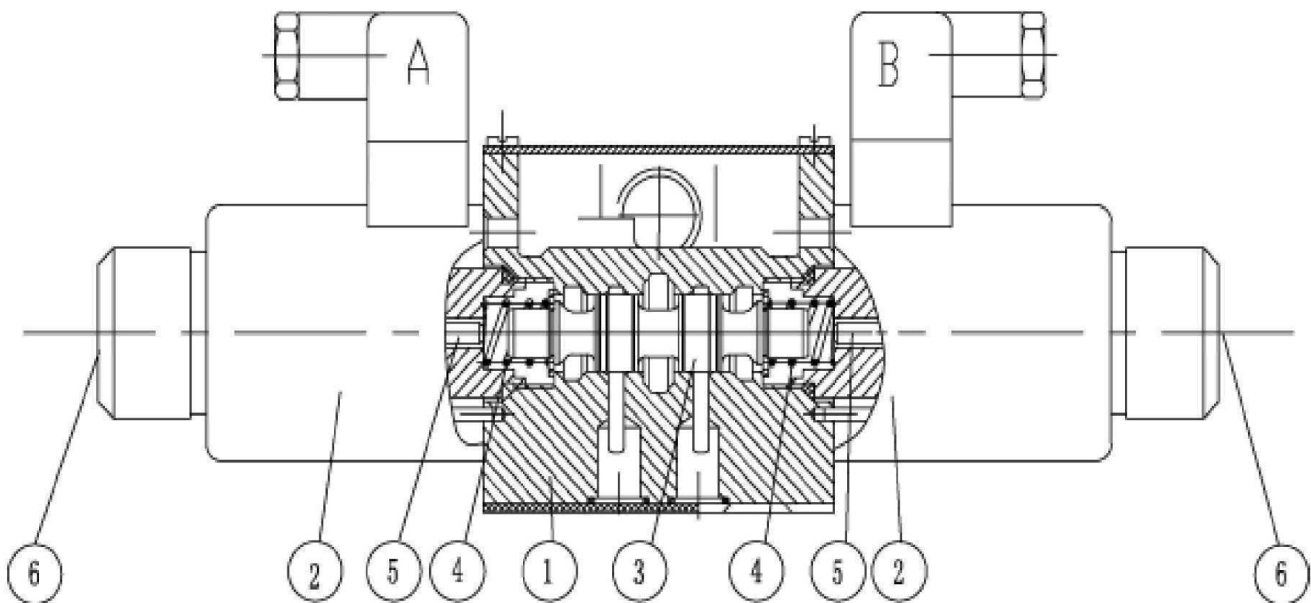

Type 4WE 10 ...30B/...C

Ordering code

WE 10 31 / C

3 service ports = 3
4 service ports = 4

Size 10 = 10

Symbols see below

Series 30 to 39 = 31
(30 to 39: unchanged installation and connection dimensions)

With spring return = No code
Without spring return, but with detent = OF
Without spring return = O

Wet pin solenoid with removable coil = C

W220= 220 V AC 50 or 240V AC 60 Hz
G24= 24 V DC
W220R = DC solinoid commuting automatically

With protected hand override (standard) = N9
Without hand override = No code
With hand override = N

Individual connections:
With component plug without plug-in connector =K4
Normal plug =Z4
Large angled plug =Z5
Large angled plug with indicator light =Z5L
Central connection:
Cable entry at side = No code
Cable entry in cover, with lamp = DL
Central connection in cover, with lamp (without angled plug-in connector) = DKL

Further details in clear text

No code = mineral oils
V = phosphate ester

No code = Without cartridge throttle
B08= Throttle, Φ 0.8 mm
B10 = Throttle, Φ 1.0 mm
B12= Throttle, Φ 1.2 mm

Symbols

4) Example:

Spool E with switching position "a"

Ordering code ..EA..

Spool E with switching position "b"

Ordering code...EB...

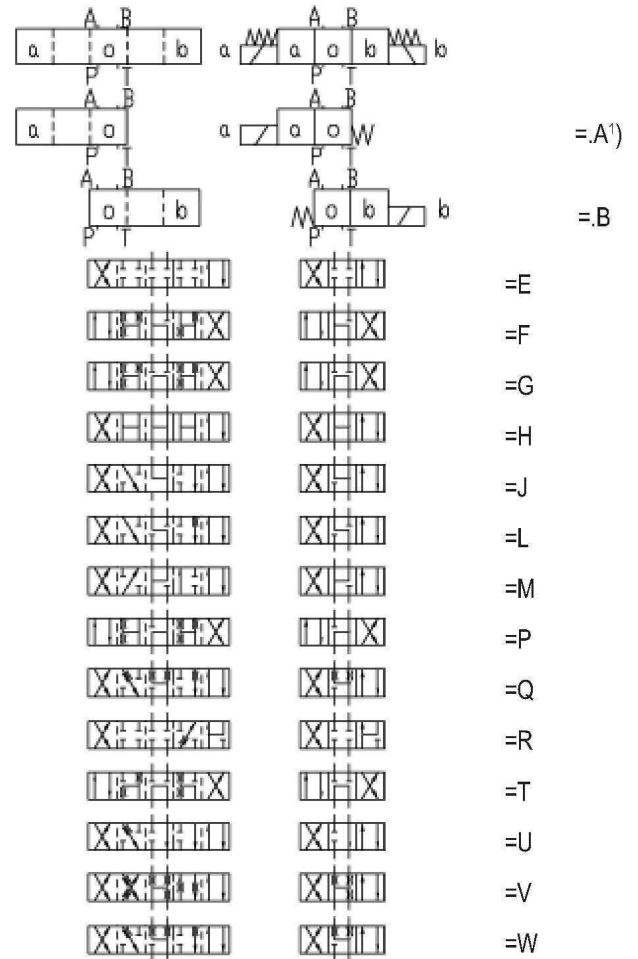
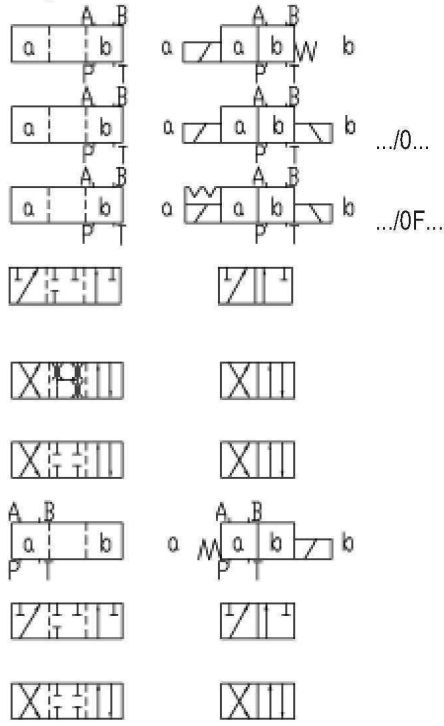

Characteristic curves (measured at $v = 41 \text{ mm}^2/\text{s}$ and $t = 50^\circ\text{C}$)

7 Symbol "R" in switched position A → B

8 Symbols "G" and "T" in mid position P → T

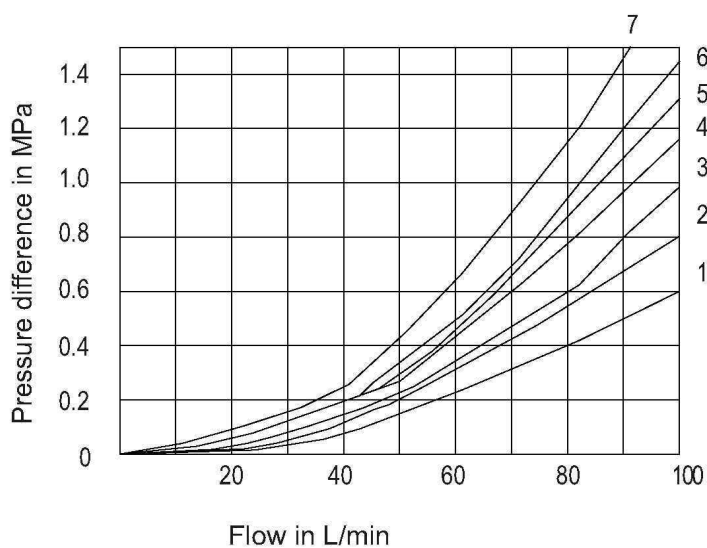

Symbols	Direction of flow			
	P-A	P-B	A-T	B-T
A, B	2	2	-	-
C, D, Y, J	2	2	3	3
E, Q, V	2	2	4	4
F	2	3	3	5
G	3	3	4	6
H	1	1	4	5
L, U	2	2	3	5
M	1	1	5	1
P	3	2	5	3
R	2	4	3	-
T	3	5	5	6
W	2	2	5	5

Switching power limits (measured at $v = 41 \text{ mm}^2/\text{s}$ and $t = 50^\circ\text{C}$)

The given switching power limits are for applications with two flow directions (e.g. from P to A and simultaneous return flow from B to T).

Due to the flow forces active within the valves the permissible switching power limit may be significantly less if there is only one direction of flow (e.g. from P to A and port B blocked)!

(Please consult us for applications of this kind.)

The switching power limits were measured with the solenoids at operating temperature, 10% under voltage and without tank back pressure.

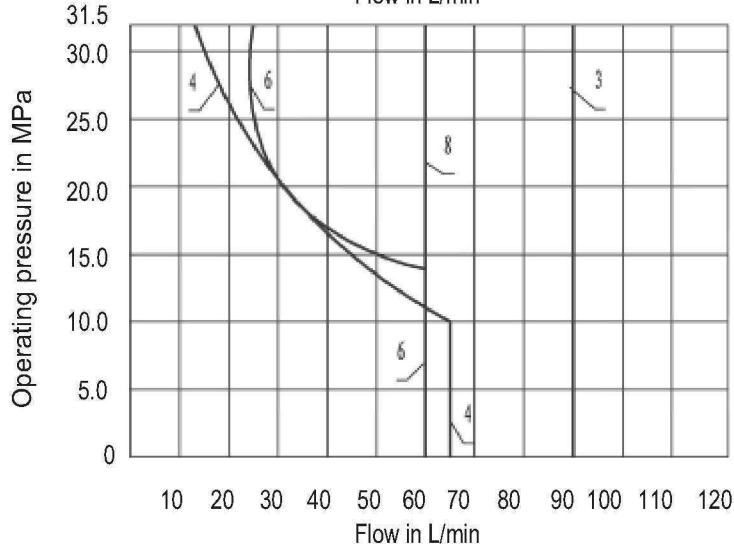
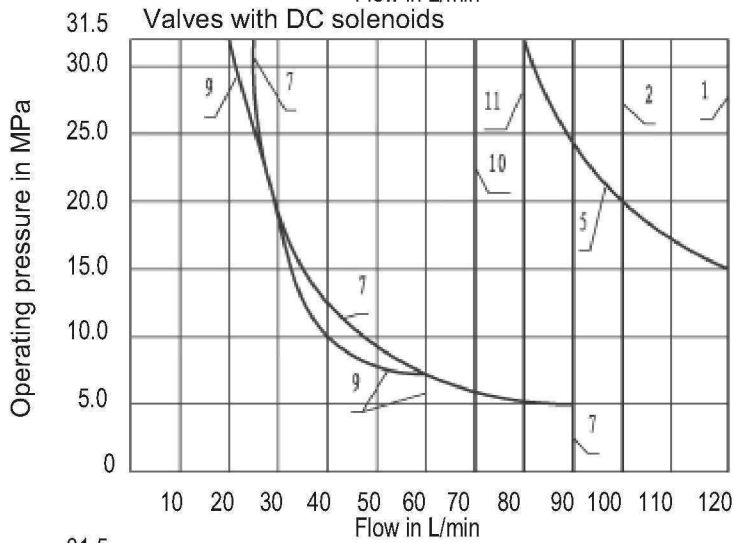
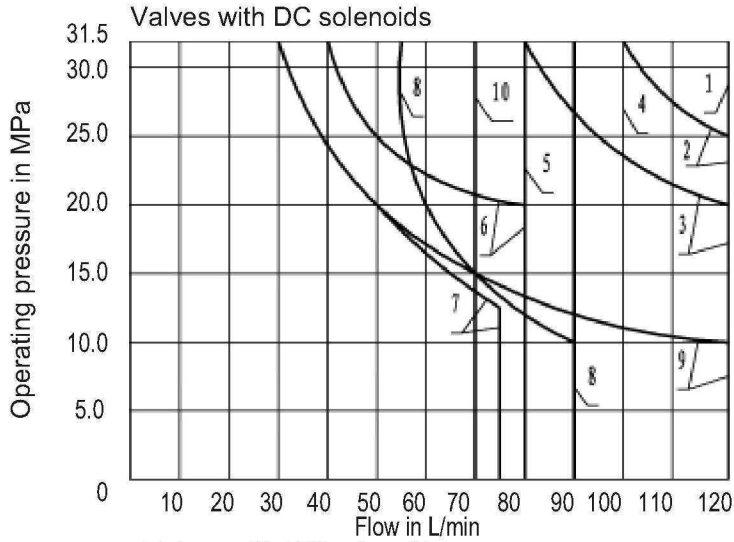

Curve	Symbols
1	C,D/O,C/O/F D,D/O,D/O/F Y,M
2	E
3	A/O,A/O/F L,U,J,Q,W
4	H
5 ¹⁾	R
6	G
7	T
8	F,P
9	A,B
10	V

42V,50Hz;110V,50Hz;120V,60Hz; 127V,50Hz;220V,50Hz;240V,60Hz	
Curve	Symbols
1	C,C/O,C/O/F D,D/O,D/O/F Y
2	E,L U,Q,W
3	M
4	A,B
5	A/O,A/O/F,J
6	G
7	F,P
8	V
9	T
10	H
11	R

Switching power limits (measured at $v = 41 \text{ mm}^2/\text{s}$ and $t = 50^\circ\text{C}$)

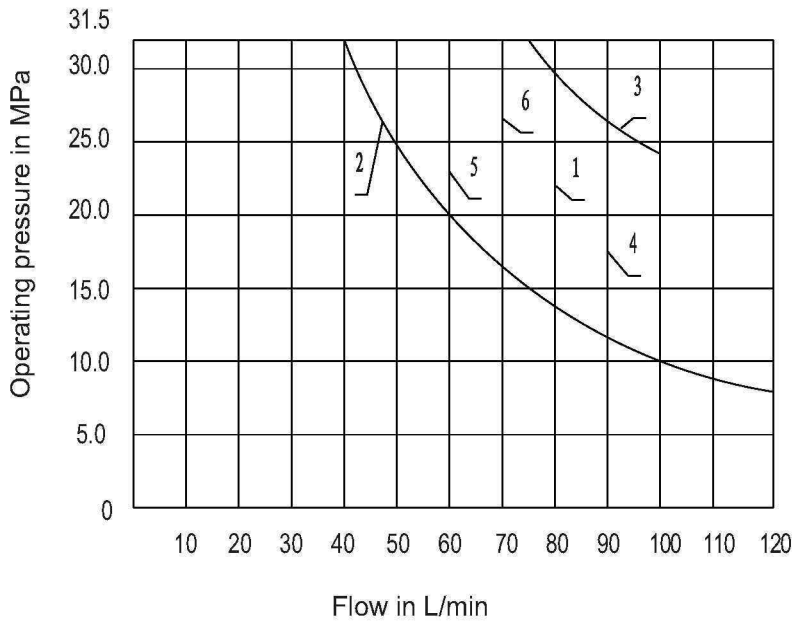

42V,60Hz,110V,60Hz 127V,60Hz,220V,60Hz	
Curve	Symbols
1	C,C/O,C/OF D,D/O,D/OF Y
2	A/O,A/OF
3	E
4	M
5	V
6	H
Switching power limits for other spools on enquiry!	

Technical data

Operating pressure max.	Ports A, B, P (MPa)	31.5
	Ports T (MPa)	16
Flow max.	(L/min)	120
Cross section (switching position 0):	With symbol Q approx. 6 % of the nominal area With symbol W approx. 3 %	
Pressure fluid	Mineral oils(for NBR seal) or phosphate ester(for FPM seal)	
Pressure fluid temperature range	($^\circ\text{C}$)	-30 ~ + 80
Viscosity range	(mm^2/s)	2.8 ~ 500
Weight (kg)	Valve with 1 solenoid	5.1(DC), 4.3(AC)
	Valve with 2 solenoids	6.7(DC), 5.1(AC)

For symbols A and B, port T must be used as a drain line, if the operating pressure is higher than the permissible tank pressure.

Unit dimensions with DC solenoids

Individual connection

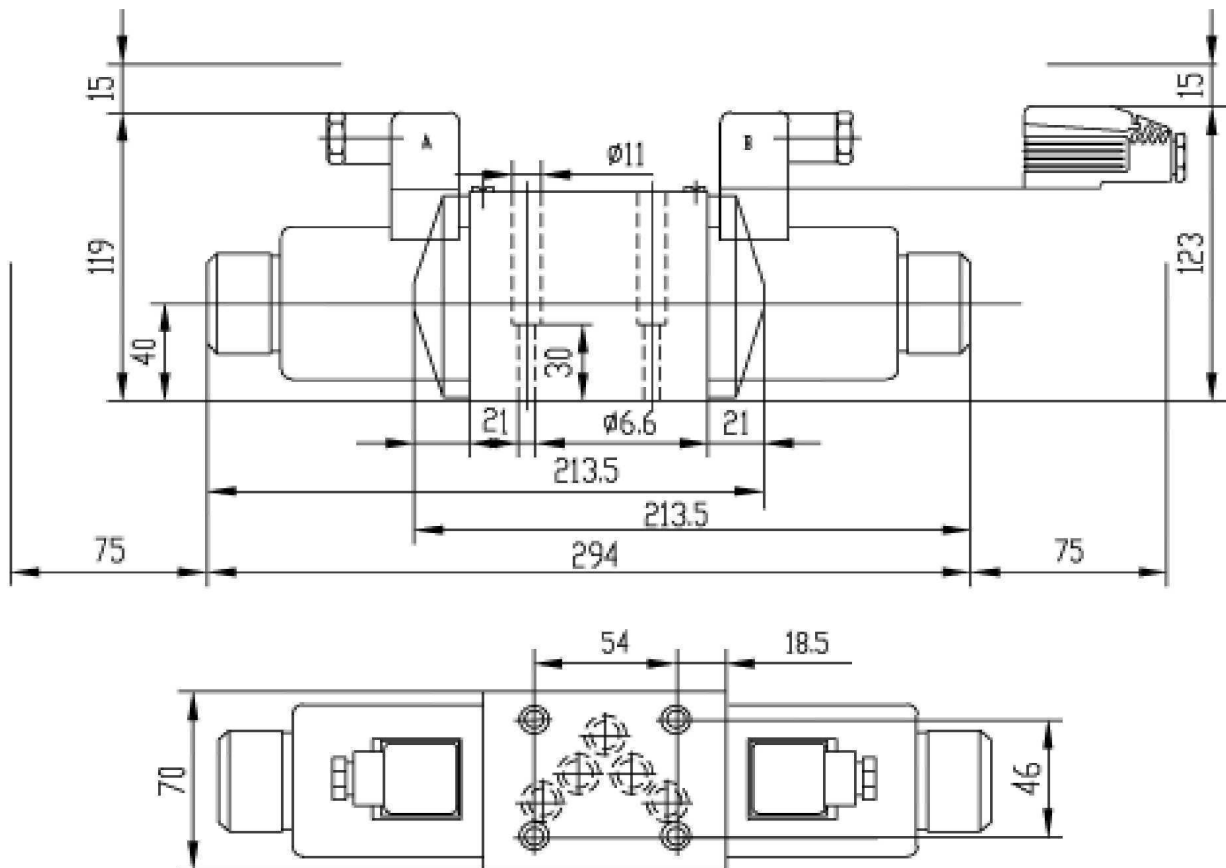

Central connection

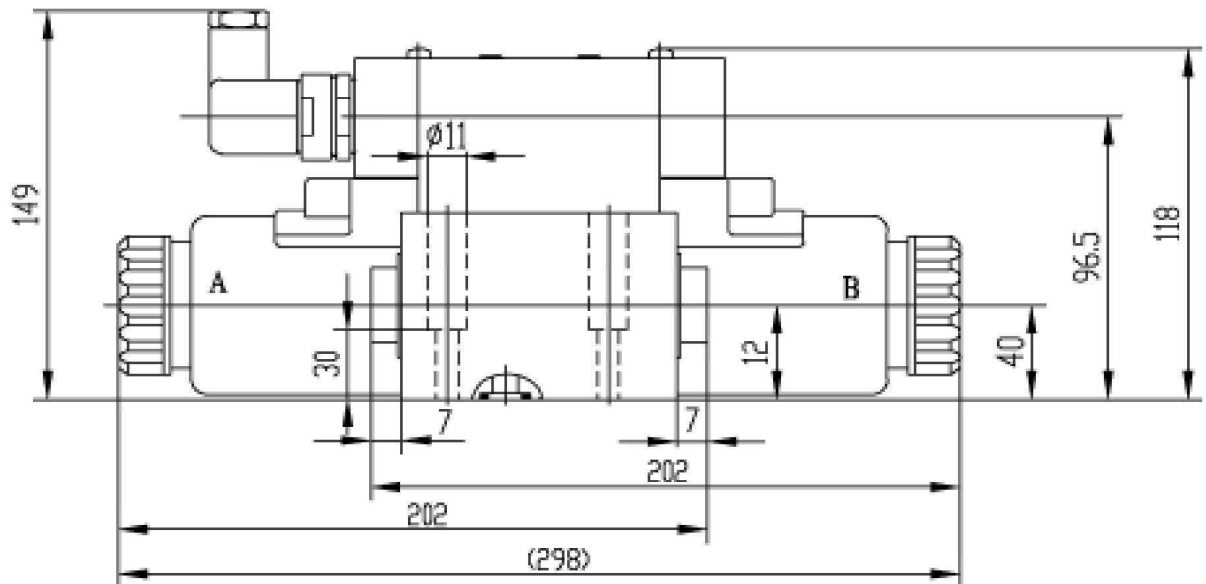

Valve fixing screws: 4-M6x40-10.9 (GB/T70.1-2000)

$M_A=15\text{N.m}$

Subplate: G66/01(G3/8 ") G66/02(M18x1.5)

G67/01(G1/2 ") G67/02(M22x1.5)

G534/01(G3/4 ") G534/02(M22x1.5)

(see page 206)

Required surface finish of mating piece

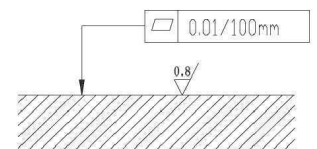

Unit dimensions with AC solenoids

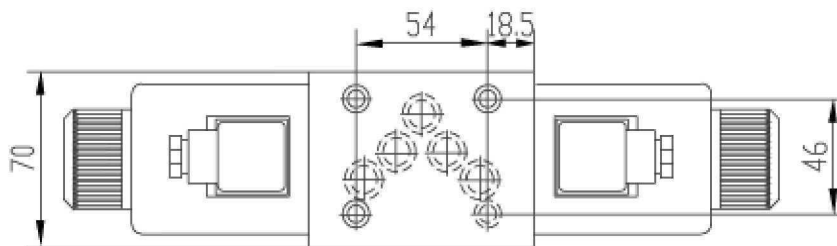
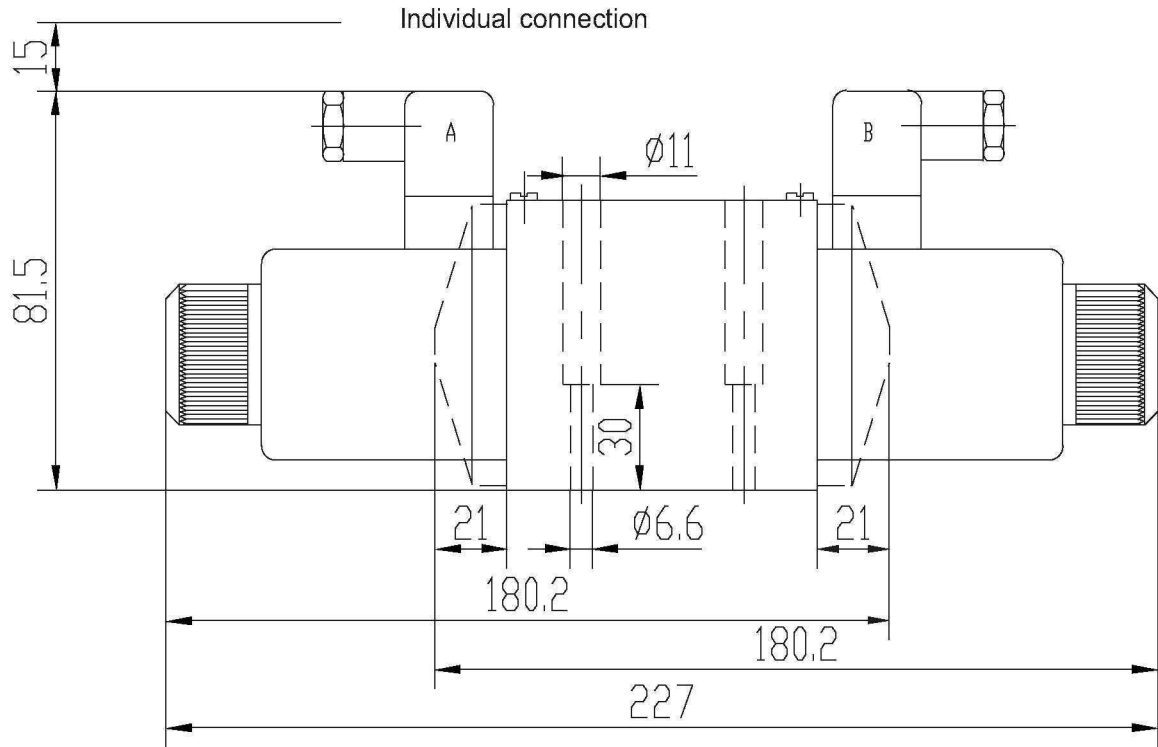

Central connection

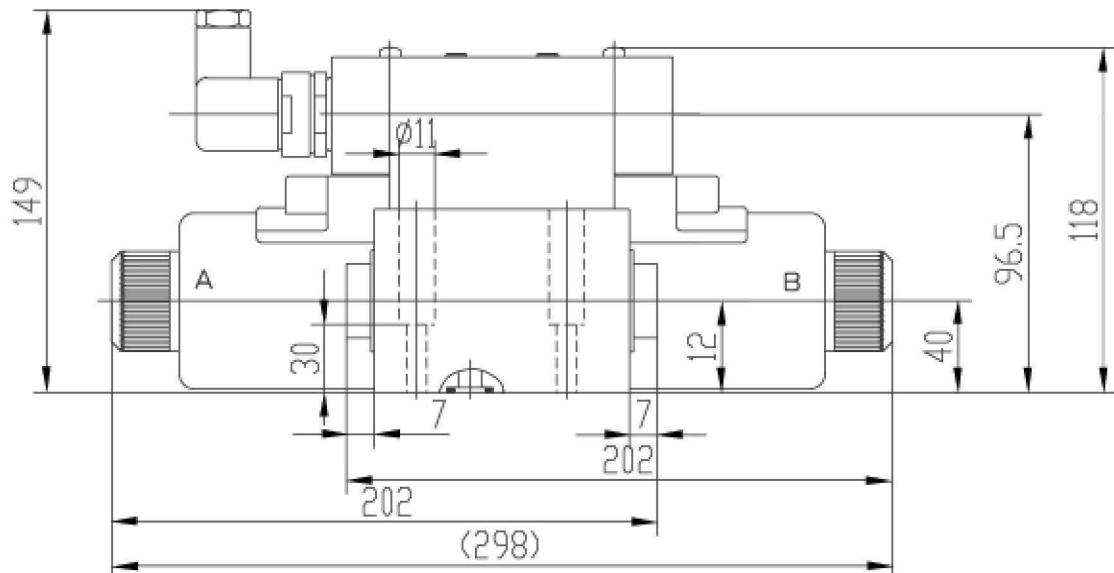

Valve fixing screws: 4-M6x40-10.9 (GB/T70.1-2000)

$M_A=15N.m$

Subplate: G66/01(G3/8 ") G66/02(M18x1.5)

G67/01(G1/2 ") G67/02(M22x1.5)

G534/01(G3/4 ") G534/02(M22x1.5)

(see page 206)

Required surface finish of mating piece

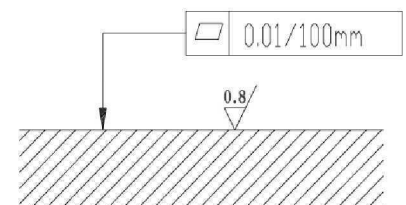

Notice

1. The fluid must be filtered. Minimum filter fineness is 20 μm .
2. The tank must be sealing up and an air filter must be installed on air entrance.
3. Products without subplate when leaving factory, if need them, please ordering specially.
4. Valve fixing screws must be high intensity level (class 10.9). Please select and use them according to the parameter listed in the sample book.
5. Roughness of surface linked with the valve is required to $\sqrt{0.8}$.
6. Surface finish of mating piece is required to 0.01/100mm.